



Professional UHF Wireless Systems

ATW-DA49 Diversity UHF Antenna Distribution System, 440-900 MHz

Installation and Operation

Prior to use of this product, review all safety markings and instructions.

	CAUTION RISK OF ELECTRIC SHOCK DO NOT OPEN	AVIS RISQUE DE CHOC ÉLECTRIQUE NE PAS OUVRIR	
---	---	---	---

To prevent electric shock, do not remove the cover. There are no user-serviceable parts inside. Internal adjustments are for qualified professionals only. Refer all servicing to qualified service personnel.

Pour prévenir un choc électrique, ne pas ouvrir le couvercle. Il n'y a aucune pièces de rechanges à l'intérieur. Tout ajustement interne doit être fait par une personne qualifié seulement. Référez tout réparation au personnel qualifié.

	Warning/Attention: To prevent fire or shock hazard, do not expose this appliance to rain or moisture. Pour prévenir feu ou choc électrique, ne pas exposé l'appareil à la pluie ou à l'humidité.
---	---

WARNING: This apparatus must be grounded.
 This product is a safety class 1 product. There must be an uninterruptible safety earth ground from the main power source to the product's AC input. Whenever it is likely that the protection has been impaired, disconnect the power cord until the ground has been restored.

ATTENTION: Cet appareil doit être mise à la terre.
 Cet appareil est de classe de sûreté 1. Il doit y avoir un ininterrompable de mise à la terre de sécurité provenant de la source principale de courant de l'appareil de l'entrée du courant alternatif. Quand la protection a été affaiblie, débrancher le fil de courant jusqu'à la mise à terre a bien été réétablie.

The detachable IEC type power input cord supplied is intended for use in regions with mains voltage in the range of 100–125VAC only. Use only the furnished power cord that includes the appropriate NEMA 5-15P/ANSI C73.11 type attachment plug.

For use in geographical areas with mains voltage outside of the range 100–125VAC, it is necessary for the user to utilize a power cord rated and configured for operation in their region. Replace the supplied power cord with a cord rated for correct voltage operation.

ATW-DA49 Installation and Operation

The ATW-DA49 is a UHF active unity-gain diversity antenna distribution system that enables one pair of antennas to feed multiple wireless systems. One ATW-DA49 unit can support up to four wireless receivers.

A wide-band unit that operates over a nominal 440-900 MHz range, the ATW-DA49 is designed to complement Audio-Technica 2000 and 3000 Series wireless systems. It is also suitable for many other wireless systems (with external BNC antenna connections) operating within the 440-900 MHz range.

The ATW-DA49 provides two identical sections, one for each antenna of a UHF diversity wireless system. Each section in the unit comprises an antenna input and four isolated receiver outputs. All RF connectors are BNC-type. Ten BNC-to-BNC RF interconnect cables are included with the unit.

Antennas can be remotely located from the unit. However, due to signal loss in cables at UHF frequencies, use the lowest-loss RF cable type(s) practical for any cable runs over 25 feet. RG-8 is a good choice. Use only copper-shielded cable, not CATV-type foil-shielded wire. The included ATW-RM1 rack-mount hardware kit with RF cables and connectors permits front-panel antenna mounting.

Either passive or active antennas may be used. Both input jacks offer switchable +12 V DC output on their center pins to operate Audio-Technica powered antennas or other in-line RF devices if desired. Up to 100 mA can be drawn from each antenna input jack.

Four jacks on the rear panel (controlled by the unit's power switch) provide 12V DC (center positive) to power as many as four receivers operating on 12 volts at up to 500 mA each. Included with the unit are four DC cables appropriate for use with ATW-R3100 or ATW-R2100 (or like-powered) receivers.

The 12-volt supplies for powering receivers are short-circuit protected. The unit features all-metal construction for extreme durability and protection from radio frequency interference.

Power Connections

The switching power supply is designed to operate properly from any AC power source 100-240V, 50/60 Hz without user adjustment. Simply connect the power supply to a standard AC power outlet, *using only an IEC 320-type input cordset approved for the country of use.*

Front Panel Controls and Functions (Fig. A)

1. POWER SWITCH: Press switch to apply power to unit. Press again to turn unit off.
2. POWER INDICATOR: The indicator will light when power is applied.

Figure A Front Panel

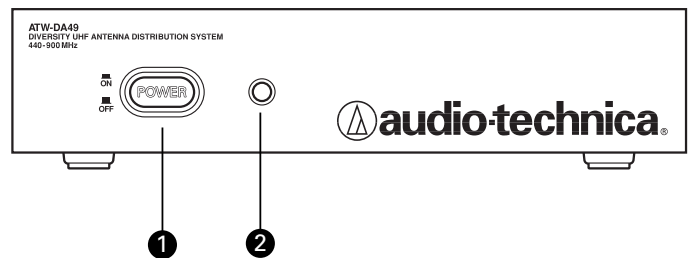

Rear Panel Controls and Functions (Fig. B)

- CHANNEL "A" ANTENNA INPUT: Attach the "A" antenna here, or extend it with a low-loss antenna cable. (Antenna and cable not included.)
- CHANNEL "A" DISTRIBUTION OUTPUTS: Four jacks provide RF distribution to receivers operating within the 440-900 MHz range. Each output should be connected to only one other antenna input. Unused outputs do not require termination.
- CHANNEL "B" ANTENNA INPUT: Attach the "B" antenna here, or extend it with a low-loss antenna cable. (Antenna and cable not included.)
- CHANNEL "B" DISTRIBUTION OUTPUTS: Four jacks provide RF distribution to receivers operating within the 440-900 MHz range. Each output should be connected to only one other antenna input. Unused outputs do not require termination.
- DC OUTPUT JACKS: Provides 12V DC (center positive) at up to 500 mA from each jack to power receivers. Connect the included ATW-RDCN cables here to supply 12V DC to up to four ATW-R2100 or ATW-R3100 (or like-powered) receivers.
- DC POWER INPUT: 3-pin header connector for +12V DC power input.

Figure B Rear Panel

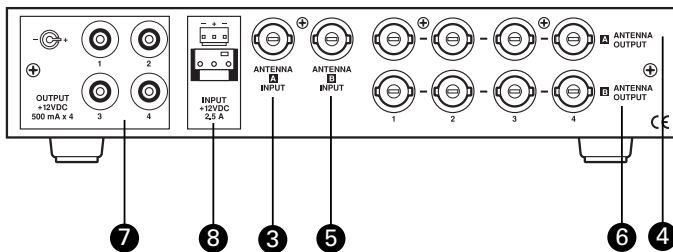

Active Antenna Power Switch (Fig. C)

NOTE: ATW-A49 antennas do not require power. If you are using ATW-A49 antennas, or any passive antennas, leave the switch in the factory-set OFF position. If you have an antenna system that requires power (such as an antenna preamp or booster) you must open the ATW-DA49 assembly and activate a switch on the circuit board. See Fig. C. (This enables the antenna distribution system to pass power through to the antenna.) Current consumption of the preamp or booster should not exceed 100 mA.

- The unit is shipped with the switch in the "off" position. To change the switch to the "on" position, first **be certain the ATW-A49 is not attached to any power source.** Next, use a Phillips screwdriver to remove the four cover screws; remove the cover; move the switch into the "on" position. Finally, replace the cover and securely tighten the screws.

Figure C Antenna Power Switch

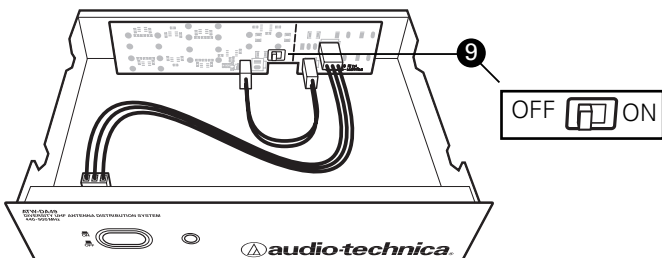

Front-mount Antennas—ATW-RM1 Rack Mount Hardware Kit (Fig. D)

- The ATW-RM1 rack-mount hardware kit (includes rack ears and hardware) is provided to permit attachment in a standard 19" audio equipment rack.
- Antennas may be mounted on the front of the long rack ear.

The following parts are included in the kit: Long rack ear; short rack ear; two BNC bulkhead connectors with mounting hardware; two 34" BNC-to-BNC cables; six rack-mount screws.

Figure D Front-mount Antennas

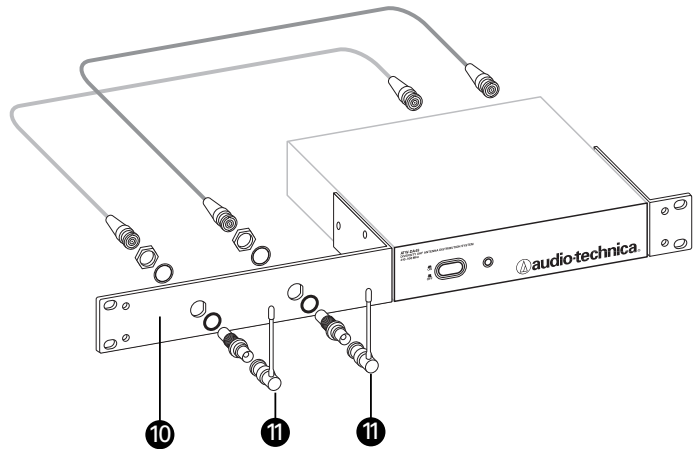

Assembling the ATW-RM1 Rack Mount Hardware Kit (Fig. D)

- Remove the nut and lock-washer from each bulkhead connector. Install the connectors *from the front* into the two holes in the long rack ear (see Fig. D). Note that the flat on the threaded section must be aligned with the flat in each panel hole.
- Install the lock-washer and nuts (included) over the back of each bulkhead connector. Secure each connector from the back with its lock-washer and nut, tightening the nut firmly.
- Connect one end of each provided BNC-BNC cable to the rear antenna input jacks on the back of the antenna distribution system amplifier. Attach the other end of each cable to the back of the BNC bulkhead connectors. Make certain the bayonet twist-rings are *fully* latched on the connectors at both ends.
- Finally, mount the receiver's antennas to each of the BNC bulkhead connectors.

ATW-DA49 Set up (Fig. E)

12. +12V DC power is supplied through the ATW-DA49 Antenna Distribution System to each receiver.
13. Channel "B" distribution output connects to antenna "B" input jack on receiver.
14. Channel "A" distribution output connects to antenna "A" input jack on receiver.

Figure E ATW-DA49 Set Up

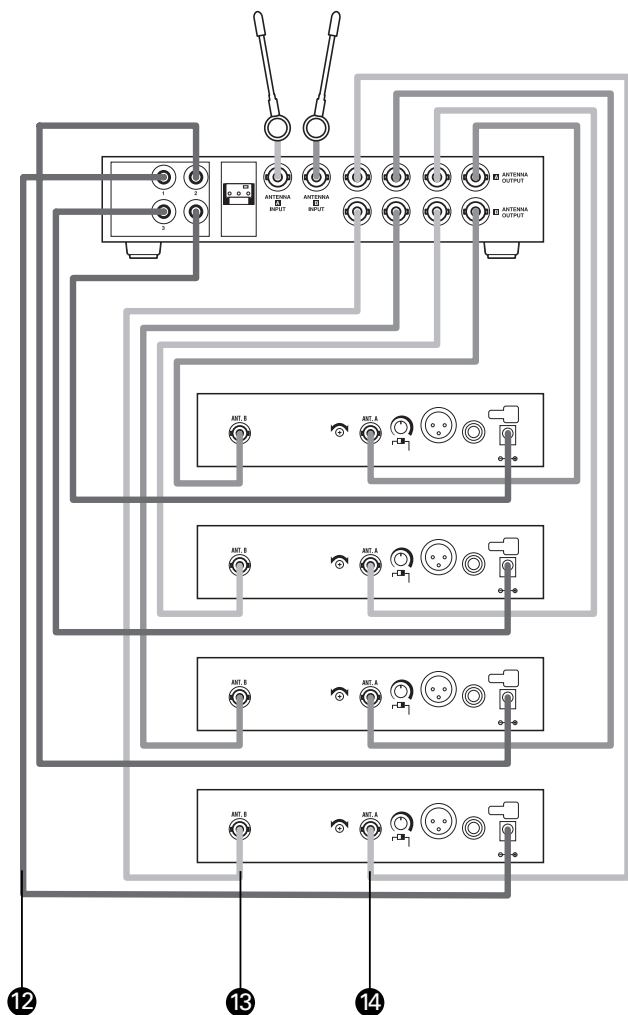

Specifications

Bandwidth	440-900 MHz
Gain	0 dB typical (within specified bandwidth)
Impedance	50 ohms typical (within specified bandwidth)
Antenna Power (optional)	+12V DC, center positive, 100 mA maximum per antenna input (2 total)
Termination Type	BNC Female (10 total)
Power Supply	Desktop Switching Power Supply Rated at 3A @ 12V DC or 36 Watts. Input Voltage 100-240V AC via detachable IEC 320/C14 cable. Output is provided on an overmolded 3-pin Molex-style termination.
Dimensions (Base unit only)	8.27" (210.0 mm) W x 1.79" (45.5 mm) H x 6.93" (176.0 mm) D
Weight	2.0 lbs. (0.9 kg)
Accessories Included	IEC 320/C14 power cable; 10 BNC-to- BNC 34" RF cables; 4 DC power interconnect cables; ATW-RM1 rack kit for front mounting antennas and adaptation to a 19" rack.

To reduce the environmental impact of a multi-language printed document, product information is available online at www.audio-technica.com in a selection of languages.

Afin de réduire l'impact sur l'environnement de l'impression de plusieurs, les informations concernant les produits sont disponibles sur le site www.audio-technica.com dans une large sélection de langue.

Para reducir el impacto al medioambiente, y reducir la producción de documentos en varios leguajes, información de nuestros productos están disponibles en nuestra página del Internet: www.audio-technica.com.

Para reduzir o impacto ecológico de um documento impresso de várias línguas, a Audio-Technica providência as informações dos seus produtos em diversas línguas na www.audio-technica.com.

Per evitare l'impatto ambientale che la stampa di questo documento determinerebbe, le informazioni sui prodotti sono disponibili online in diverse lingue sul sito www.audio-technica.com.

Der Umwelt zuliebe finden Sie die Produktinformationen in deutscher Sprache und weiteren Sprachen auf unserer Homepage: www.audio-technica.com.

Om de gevolgen van een gedrukte meertalige handleiding op het milieu te verkleinen, is productinformatie in verschillende talen "on-line" beschikbaar op: www.audio-technica.com.

本公司基於環保理由將減少多語言文件印刷，陸續產品訊息可在 www.audio-technica.com 的官方網頁上選擇語言與瀏覽。

本公司基于环保理由将减少多语言文件印刷，陆续产品信息可在 www.audio-technica.com 的官方网页上选择语言与浏览。

자원절약, 환경보호를 위해 국문 사용 설명서는 인쇄하지 않았습니다. 제품정보는 www.audio-technica.com 에서 원하는 언어 선택 후에 다운로드 받으실 수 있습니다.

Extensive information about using wireless systems and accessories is available on the Audio-Technica Web site at www.audio-technica.com



Audio-Technica U.S., Inc., 1221 Commerce Drive, Stow, Ohio 44224 330/686-2600
Audio-Technica Limited, Old Lane, Leeds LS11 8AG England (0)113 277 1441